

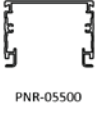

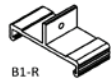







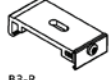

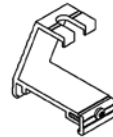

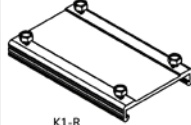
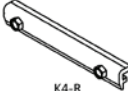
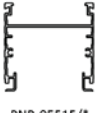
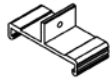

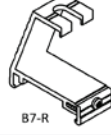

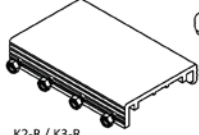
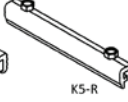
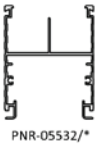
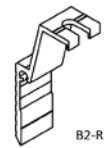
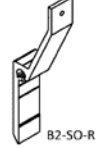
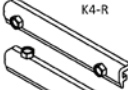

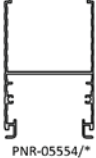
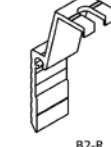



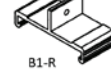
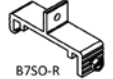



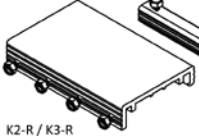
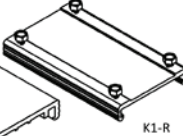
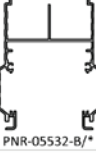
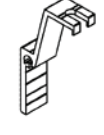
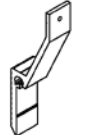

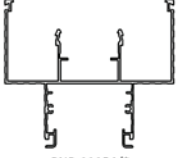
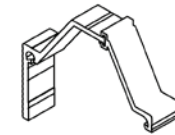
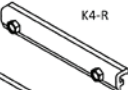
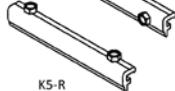
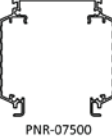
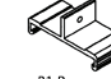
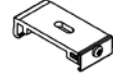
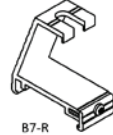
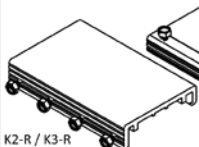
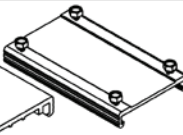

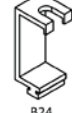



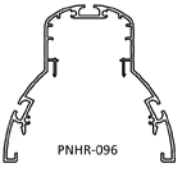

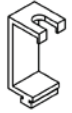



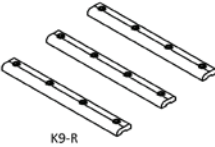





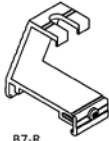
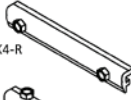
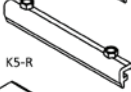
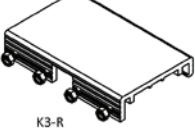

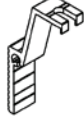

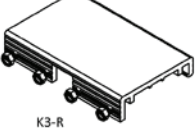

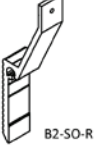

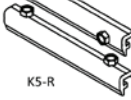

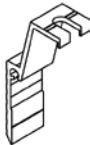





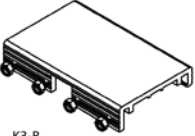





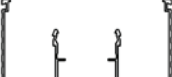
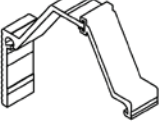
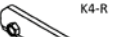
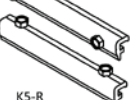

Profile	Brackets	Connecting pieces
 PNR-05500	 B1-R  B750-R  B3-R  B3-CR  B7-R  B0-60 (adjustable angle)	 K1-R  K4-R
 PNR-05515/*	 B1-R  B2-S-733-R  B2-SO-733-R  B7-R  B750-R	 K2-R / K3-R  K5-R
 PNR-05532/*	 B2-R  B2-SO-R	 K4-R  K5-R
 PNR-05554/*	 B2-R  B2-SO-R	 K4-R  K5-R
 PNR-05500-B	 B1-R  B750-R  B3-R  B3-CR  B7-R  B0-60 (adjustable angle)	 K2-R / K3-R  K1-R
 PNR-05532-B/*	 B2-S-733-R  B2-SO-733-R	 K4-R  K5-R
 PNR-11154/*	 B8-R / B850-R	 K4-R  K5-R
 PNR-07500	 B1-R  B3-R  B7-R	 K2-R / K3-R  K1-R
 PNHR-05500	 B14  B24  BSK  B35  B35-C	 K7-R
 PNHR-096	 B14  B24  BSK  B35  B35-C	 K9-R

* Indicated brackets for profiles with cable gutter apply, regardless of the indicated amount of spacers on the profile (PNR-.../0~/1~/2/).

Note: applicability of bracket may vary, depending on the surrounding, light line configuration, light line application and/ or IP-class.

Note: K4-R and K5-R brackets are available in various lengths, so the amount of used screws may vary from illustrated as above.

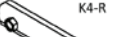
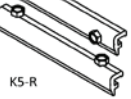

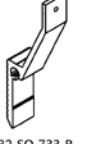
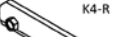
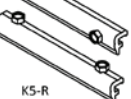





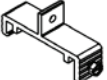

Profile	Brackets	Connecting pieces
 PNR-05500	 B3-R  B3-CR  B7SO-R  B7-R	 K4-R  K5-R  K3-R
 PNR-05515/*	 B7SO-R  B2-S-733-R  B2-SO-733-R  B7-R	 K3-R
 PNR-05532/*	 B2-R  B2-SO-R	 K4-R  K5-R
 PNR-05554/*	 B2-R  B2-SO-R	 K4-R  K5-R
 PNR-05500-B	 B7SO-R  B7-R	 K3-R
 PNR-05532-B/*	 B2-S-733-R  B2-SO-733-R	 K4-R  K5-R
 PNR-11154/*	 B8-R / B8SO-R	 K4-R  K5-R
 PNHR-05500	 B35  B35-C  BSK	 K7-R
 PPR-05515/*	 B83-PPR	
 PSWR-05532/*	 B2-R  B2-SO-R	 K4-R  K5-R
 PSWR-05532-B	 B2-S-733-R  B2-SO-733-R	 K4-R  K5-R

* Indicated brackets for profiles with cable gutter apply, regardless of the indicated amount of spacers on the profile (PNR-.../0~1~/2).

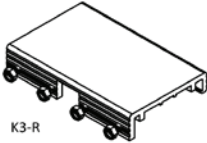
Note: applicability of bracket may vary, depending on the surrounding, light line configuration, light line application and/ or IP-class.

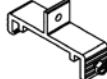
Note: K4-R and K5-R brackets are available in various lengths, so the amount of used screws may vary from illustrated as above.

Profile	Brackets			Connection pieces
 <p>PWR-05500</p>	 <p>B3-R</p>	 <p>B7SO-R</p>	 <p>B7-R</p>	 <p>K3-R</p>
 <p>PWR-05500-B</p>	 <p>B3-R</p>	 <p>B7SO-R</p>	 <p>B7-R</p>	

Note: applicability of bracket may vary, depending on the surrounding, light line configuration, light line application and/ or IP-class.